

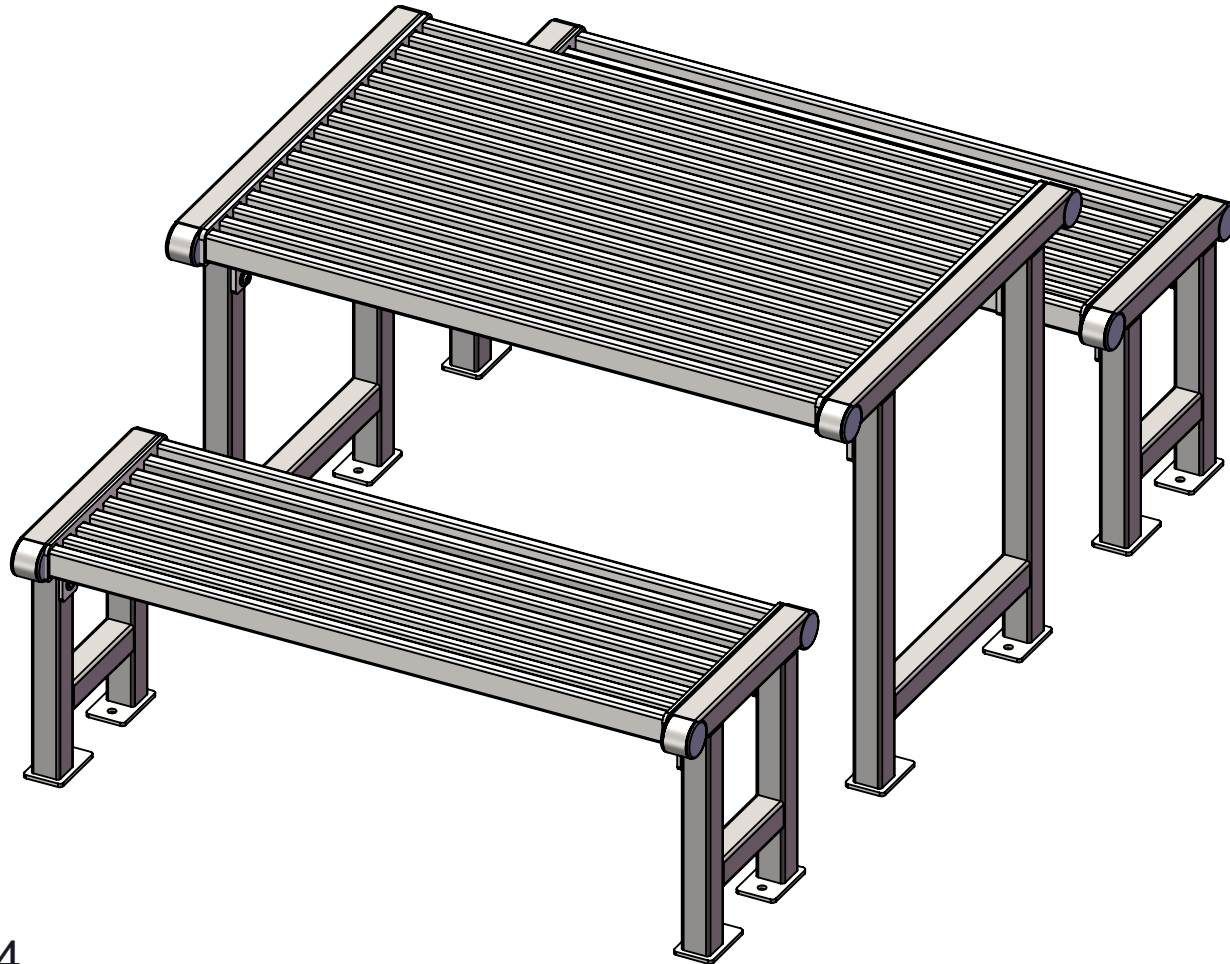

A PLAYCORE Company



Model # 920-S4



A PLAYCORE Company

SAFETY WARNINGS & EQUIPMENT INSPECTION

- Owners and installers please note these safety warnings and make use of this checklist on a regular basis.
- Follow installation instructions when erecting equipment.
- Ground surfaces around equipment should be restored as needed. Concrete footings should never be exposed. Surface depth should comply with ASTM and CPSC specifications.
- Check for and repair damage caused by wear or vandalism, a major factor in injury causing situations.
- All protruding bolts should be covered or cut off and finished smooth. Sharp edges on pipes should be capped or removed. Check for bent, broken, or severely worn pipe, and replace.
- All equipment should be free of rust and repainted whenever necessary to deter rusting.
- We provide our customers with layout sheets and installation instructions. Please keep on file the specifications sheet that contains the listing of every part used.
- Never add components not intended for use with this product.
- Regular maintenance is necessary in this and all park and recreational equipment to insure the safety of the user.
- Note: Proper maintenance of equipment requires regular tightening of all bolts, nuts, and setscrews.
- Note: Regular checking of all parts, castings, etc. should be made. If a part is broken or worn, it should be replaced immediately.
- Check to be sure all fittings are tight and that bars and pipes do not move.
- Replace all worn S-hooks. S-hooks must be completely closed. Failure to close S-hooks can result in serious injury to the user. NEVER reuse S-hooks.
- Test for free movement of swing hanger and other moving attached parts.
- Check for worn chains and replace them.
- A soft resilient surface should be placed under all swings extending at least twice the height of the top rail both front and back.

HARDWARE

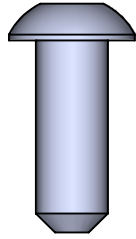

3/8" x 1" Button
Head Bolt (SS)

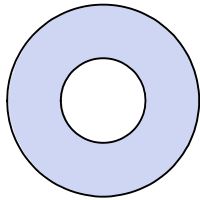

3/8" Washer

TOOLS REQUIRED



7/32" Allen Wrench

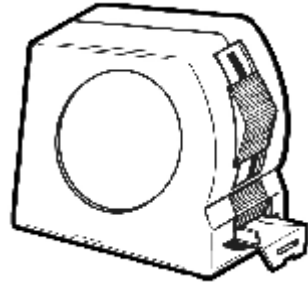

Tape Measure

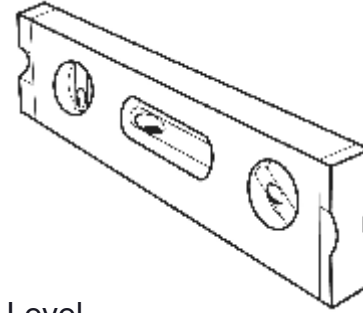

Level

ULTRA SITE PRODUCT SPECIFICATIONS

920-S4 SAVANNAH SURFACE MOUNT TABLE WITH SEATS

Seats and Top: Seats and Top are fabricated from 1" x 1" x 11 ga. steel square tubing. End rails shall be 1" x 2" x 13 ga. steel rectangular tubing. Seat attachment plates shall be laser cut from 1/4" steel. All electrically MIG welded.

Frame: Seat and Table end frames shall be fabricated from 2" x 2" x 11 gauge pre-galvanized steel square tubing. Surface mounting plates shall be 2-3/4" x 1/4" steel plate. All electrically MIG welded.

Powdercoat Coating: Steel is sandblasted to near white condition. Coated with zinc rich epoxy primer and top coated with electrostatic powder coat, oven cured.

or

Thermo Coating: Oven fused functionalized polyethylene copolymer-based thermoplastic. Fluidized bed coating application with superior mechanical performance, impact resistance and UV-stability.

Hardware: All stainless steel allen head fasteners.

Dimensions: 4' surface mount table with seats: Seats are 15-1/2" wide x 44" long. Seat height is 18-1/4" from the ground to the top of the seat. Table is 30" wide x 44" long. Table Top height is 30-1/4" from the ground to the top of table top. The overall dimensions are 48" x 73-1/2" x 30-1/4".

COMPONENTS

Attach the 920 Seat and Table Legs to the 4' Seats and Top using specified hardware.

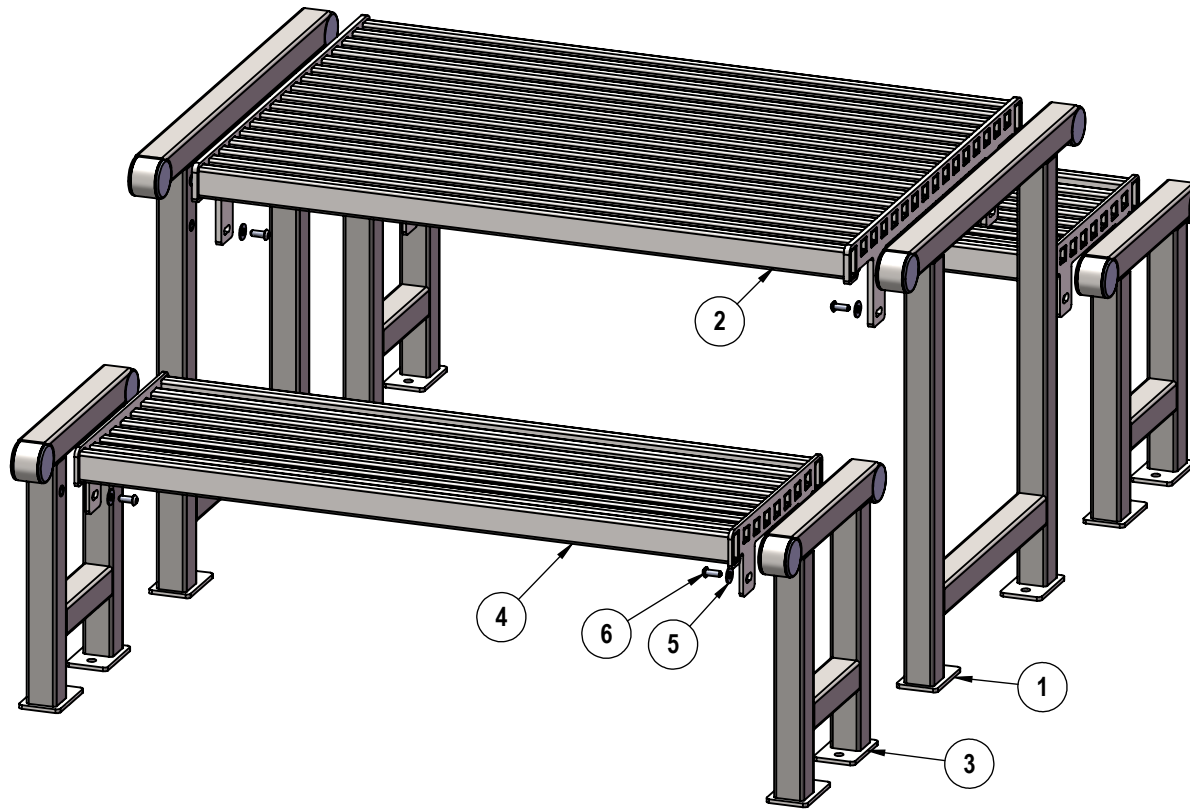

ITEM NO.	PartNo	DESCRIPTION	Qty.
1	01-04-0801	920 table leg	2
2	01-04-0810	920 4' table top	1
3	01-04-0796	920 table seat leg	4
4	01-04-0806	920 4' table seat	2
5	33-02-0008	3/8" Flat Washer (SS)	16
6	33-06-0052	3/8"-16 x 1" Button Bolt (SS)	16

Recommended Surface Mount Hardware:
3/8" x 3-1/2" Concrete Expansion Anchor Bolts
(Not Included)

OVERALL DIMENSIONS

