



A PLAYCORE Company



Model # 411S-R8



A PLAYCORE Company

SAFETY WARNINGS & EQUIPMENT INSPECTION

- Owners and installers please note these safety warnings and make use of this checklist on a regular basis.
- Follow installation instructions when erecting equipment.
- Ground surfaces around equipment should be restored as needed. Concrete footings should never be exposed. Surface depth should comply with ASTM and CPSC specifications.
- Check for and repair damage caused by wear or vandalism, a major factor in injury causing situations.
- All protruding bolts should be covered or cut off and finished smooth. Sharp edges on pipes should be capped or removed. Check for bent, broken, or severely worn pipe, and replace.
- All equipment should be free of rust and repainted whenever necessary to deter rusting.
- We provide our customers with layout sheets and installation instructions. Please keep on file the specifications sheet that contains the listing of every part used.
- Never add components not intended for use with this product.
- Regular maintenance is necessary in this and all park and recreational equipment to insure the safety of the user.
- Note: Proper maintenance of equipment requires regular tightening of all bolts, nuts, and setscrews.
- Note: Regular checking of all parts, castings, etc. should be made. If a part is broken or worn, it should be replaced immediately.
- Check to be sure all fittings are tight and that bars and pipes do not move.
- Replace all worn S-hooks. S-hooks must be completely closed. Failure to close S-hooks can result in serious injury to the user. NEVER reuse S-hooks.
- Test for free movement of swing hanger and other moving attached parts.
- Check for worn chains and replace them.
- A soft resilient surface should be placed under all swings extending at least twice the height of the top rail both front and back.

HARDWARE



5/16" x 1-1/4" Lag Bolt

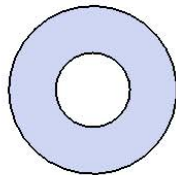

5/16" Flat Washer

TOOLS REQUIRED

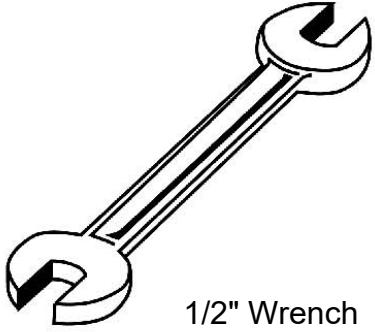

1/2" Wrench

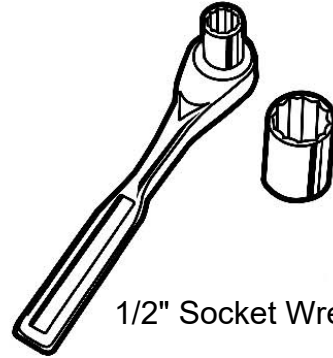

1/2" Socket Wrench

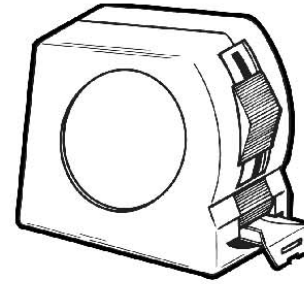

Tape Measure

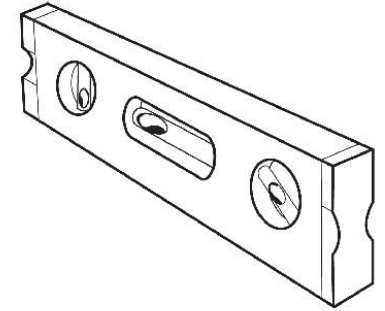

Level

ULTRA SITE PRODUCT SPECIFICATIONS

411S-R8 DENALI INGROUND BENCH WITHOUT BACK

Seat: Minimum of 96% commingled post-consumer or post-industrial recycled plastic 2x4. With a maximum of 4% due to various additives including color and UV stabilization to obtain desirable properties.

Frame: 2-3/8" O.D. x 12 gauge pre-galvanized structural steel tubing. Seat/back support is bent over a mandrel through the bend radius producing a wrinkle free bend. Tube ends are pre-galvanized steel capped. Support brackets are 7ga laser cut steel. All electrically MIG welded.

Coating: Steel is sandblasted to near white condition. Coated with zinc rich epoxy primer and top coated with electrostatic powder coat, oven cured.

Hardware: Hardware shall be stainless steel.

Dimensions: 8' inground bench without back. Seats are 20" wide x 96" long. Seat height is 20" from the ground to the top of the seat. The overall dimensions are 96" x 23-11/16" x 22"

COMPONENTS



ITEM NO.	PartNo	DESCRIPTION	QTY
1	01-01-1196	411 Denali Leg IG LH	1
2	01-01-1195	411 Denali Leg IG RH	1
3	WGR96-2x4-DB	2 x 4 Woodgrain Recycled Denali Bench Plank (8')	3
4	WGR96-2x2-DB	2 x 2 Woodgrain Recycled Denali Bench Plank (8')	6
5	33-02-0007	5/16" SS Washer	27
6	33-05-0034	5/16" x 1-1/4" lag bolt, SS	27
7	01-01-1197	411 Denali Attachment Bracket	1
8	01-01-1204	8' Denali Recycled Bench Angle- 85.75"	2

WARNING: Overtightening of lag bolts can cause damage to lumber.

STEP 1

Attach the 2x4 planks to the legs and attachment bracket as shown below using specified hardware.
The steel support angles should be installed on the bottom side of the legs/ attachment brackets on the first and third seat plank.

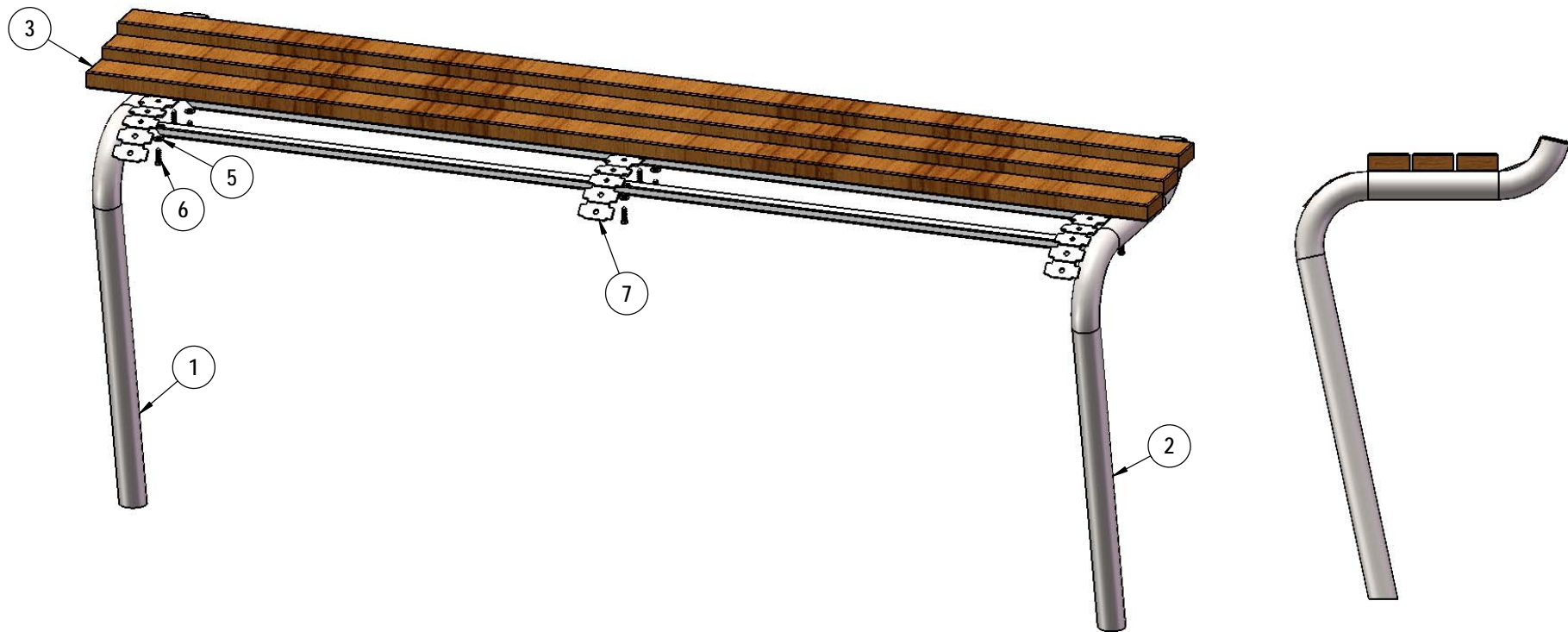

STEP 2

Attach the 2x2 planks to the legs as shown below using specified hardware.

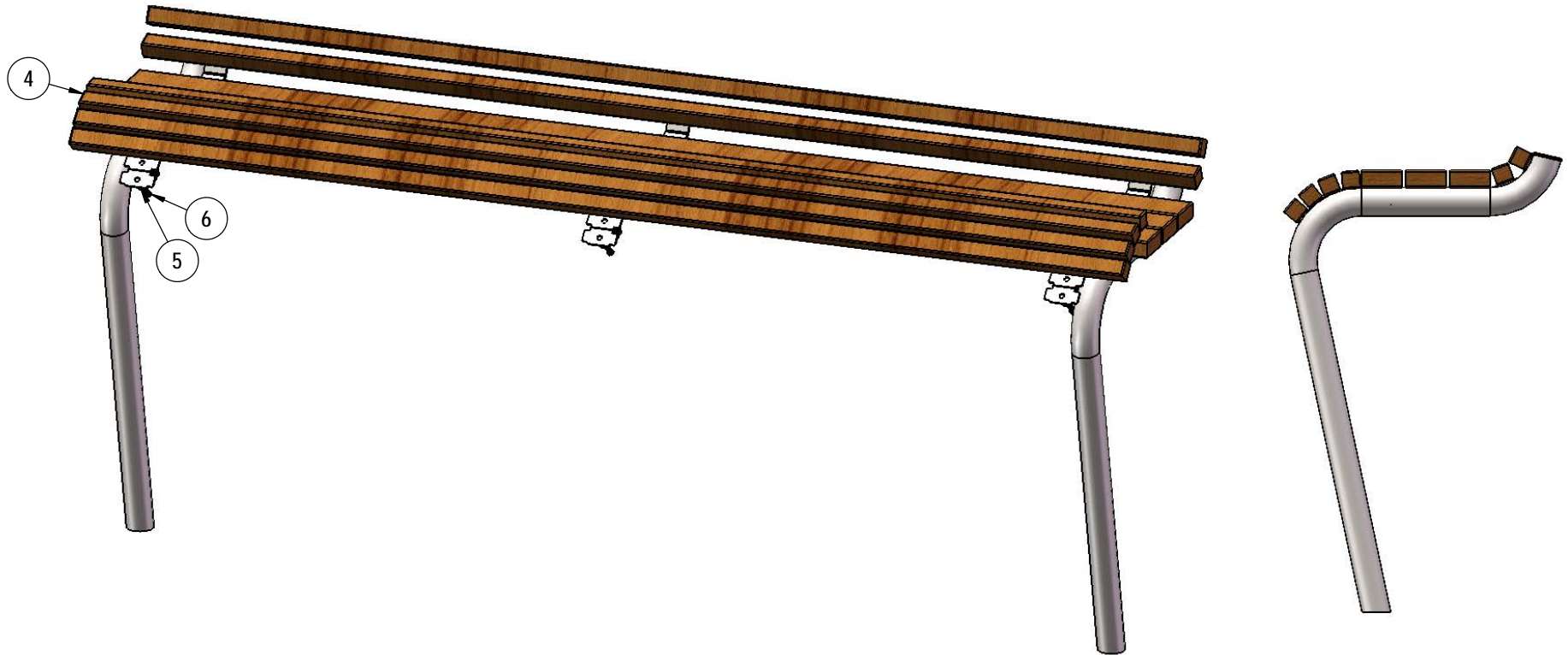

FOOTINGS

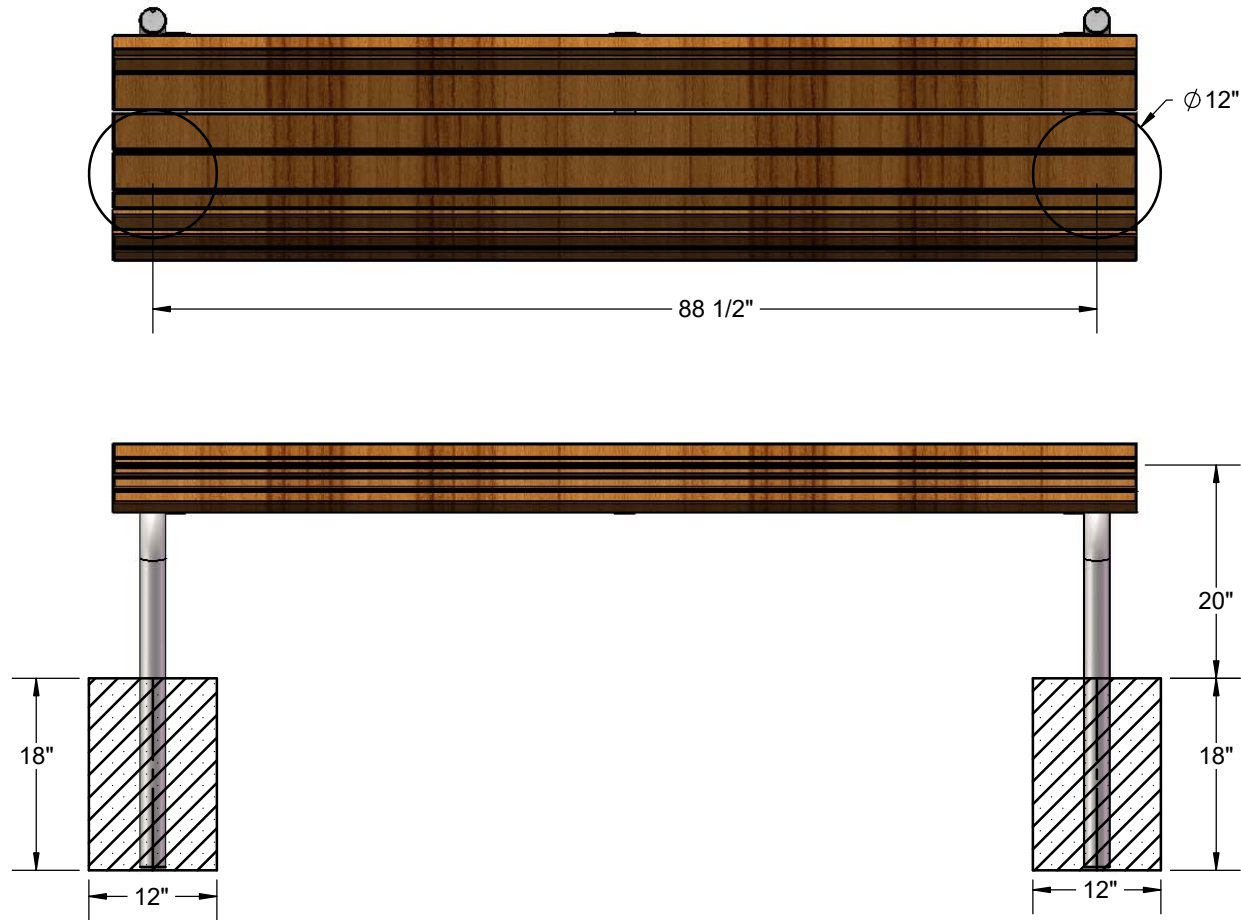

Estimated Required Concrete:
7 - 50lb Bags of Concrete Mix

OVERALL DIMENSIONS

